

SPLIT OFF

SPLIT ON (NORTH)

SPLIT ON (SOUTH)

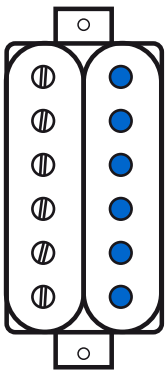

### DYNAMIC SPLIT SYSTEM

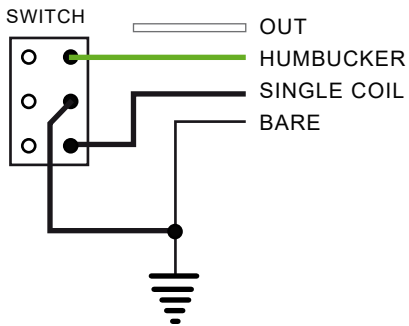

OMNIA BRIDGE HUMBUCKER

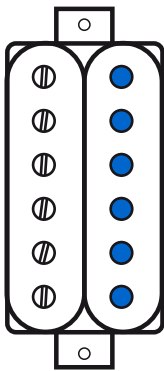

STANDARD STRATO

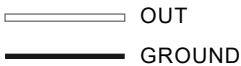
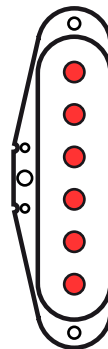

OMNIA NECK HUMBUCKER

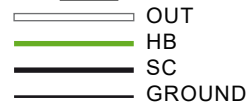
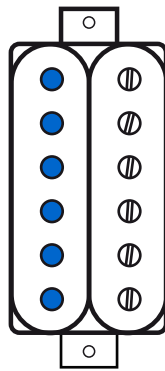

OMNIA BRIDGE HUMBUCKER

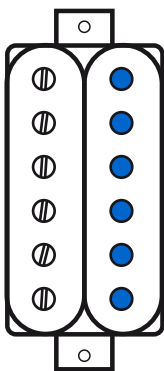

STANDARD STRATO

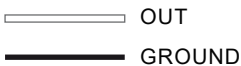
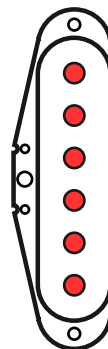

REVERSE (RWRP) STRATO

